



上品綜合工業股份有限公司
股票代號：4770

2022年第三季法人說明會

Nov 22th, 2022

免責聲明

本簡報及同時發佈之預測性資訊，皆基於當前情況之預期以及對未來事件的預測，未來若有任何變更或調整時，本公司並不負責隨時提醒或更新。

預測性資訊依然受未知的風險、不確定因素以及其他因素之影響，故本公司未來實際所發生的營運結果、財務狀況，業務展望以及營運擴張，可能與預測性資訊有所差異。

Contents

- | | |
|----------|---------------------------------------|
| 1. 公司簡介 | CFO, Bryson Liu |
| 2. 經營績效 | CFO, Bryson Liu |
| 3. Q & A | Chairman, John Hou
CFO, Bryson Liu |



01 公司簡介

關於上品



關於上品

上品公司建業40餘年，深厚實力扎根，傳承台灣優秀管理經驗與企業文化，立足全球市場經濟蓬勃向上發展之勢，厚積薄發。40多年來專注與敬業，創造完美品質產品，實現企業健全發展。



創立時間
1981年



實收資本額
TWD 792 Million



營業收入(2021)
TWD 3.83 Billion



員工人數
725人

集團分佈據點



China

Taiwan

U.S.A.

**FSC 上品兴業氟塑料(嘉兴)有限公司
ALLIED SUPREME (JIA XING) CORP.**



**FSC 上品綜合工業股份有限公司
ALLIED SUPREME CORP.**



AFTC ASTON FLUOROTECH CORP.



<https://www.alliedsupreme.com/>

主要產品及產業概況 / 公司產業地位

上游原料

Fluoropolymer
Raw Material Provider



<https://www.alliedsupreme.com/>

上品集團生產產品

Semi-Finished
Products



Final Products



下游客戶

Customers

IC Industry
(半導體產業)

EL Chemical Industry
(電子化學品產業)

LCD Industry
(面板產業)

Petrochem
(化工產業)

主要產品分類



氟素樹脂材料

因應半導體及各產業所需的氟素樹脂 (PTFE、M-PTFE、PFA、PFA HP、FEP... 等) 產品，上品研發並製作氟素樹脂內襯板材與焊接材料。

<https://www.alliedsupreme.com/>



氟素樹脂內襯

氟素樹脂內襯產品廣泛的應用於半導體設備、生化科技、製藥和精密化學工業等高純度要求的桶槽、槽車和所有藥液接觸的容器，以及客製化的熱交換器、溢流槽、治具等。



氟素工程

因應半導體及各產業所需，上品提供流體力學計算、高純化學品設備系統之設計規劃、製造及安裝一套完整的服務

主要產品 / 氟素樹脂材料

內襯板材與素板

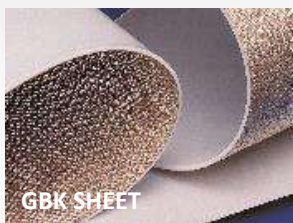

內襯直管用管材



客製化射出件



主要產品 / 氟素樹脂內襯



槽車



TEFPASS® 內襯管



過濾器



TEFPASS® 蛇管



TEFPASS® 塔節



閥件



內襯桶槽/設備



熱交換器

E.L. Sheet Lining ISO-Tank



<https://www.alliedsupreme.com/>

全方位氟素工程服務上品夥伴全球布局

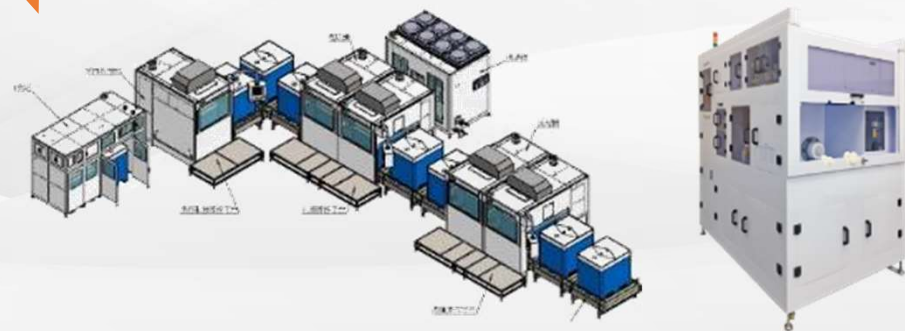
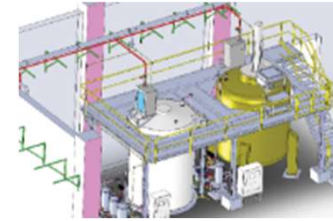
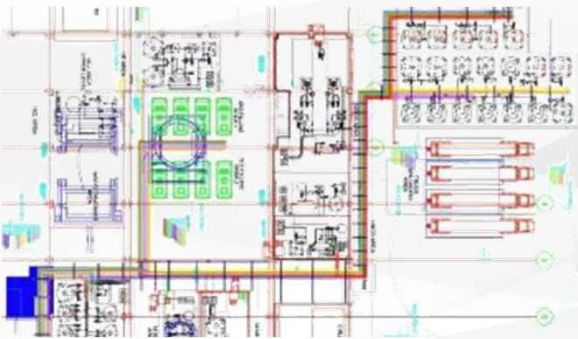
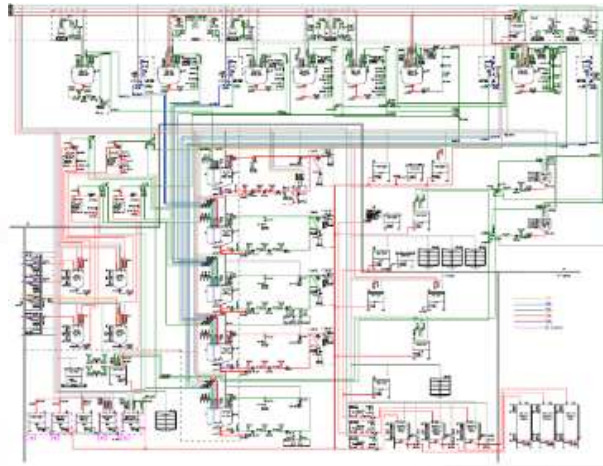



02

經營績效

季度合併綜合損益表

(In NT\$ thousands)

會計科目	End of Sep, 22	3Q22	2Q22	QoQ	3Q21	YoY
營業收入	4,507,418	1,530,201	1,592,945	-3.9%	1,037,747	47.5%
營業毛利	2,001,628	714,793	709,429	0.8%	450,605	58.6%
營業費用	468,075	169,464	145,601	16.4%	105,083	61.3%
營業淨利	1,533,553	545,329	563,828	-3.3%	345,522	57.8%
營業外收支	50,591	30,792	(1,155)	-2766.0%	(4,164)	-839.5%
稅前淨利	1,584,144	576,121	562,673	2.4%	341,358	68.8%
本期淨利	1,270,658	467,028	444,173	5.1%	277,873	68.1%
每股盈餘	16.15	5.92	5.66	0.27	4.02	1.90
比率 %	End of Sep, 22	3Q22	2Q22	QoQ	3Q21	YoY
毛利率	44.4%	46.7%	44.5%	2.2%	43.4%	3.3%
營業費用率	10.4%	11.1%	9.1%	1.9%	10.1%	0.9%
營業利益率	34.0%	35.6%	35.4%	0.2%	33.3%	2.3%
稅前淨利率	35.1%	37.7%	35.3%	2.3%	32.9%	4.8%
純益率	28.2%	30.5%	27.9%	2.6%	26.8%	3.7%

季度營業收入

(In NT\$ thousands)

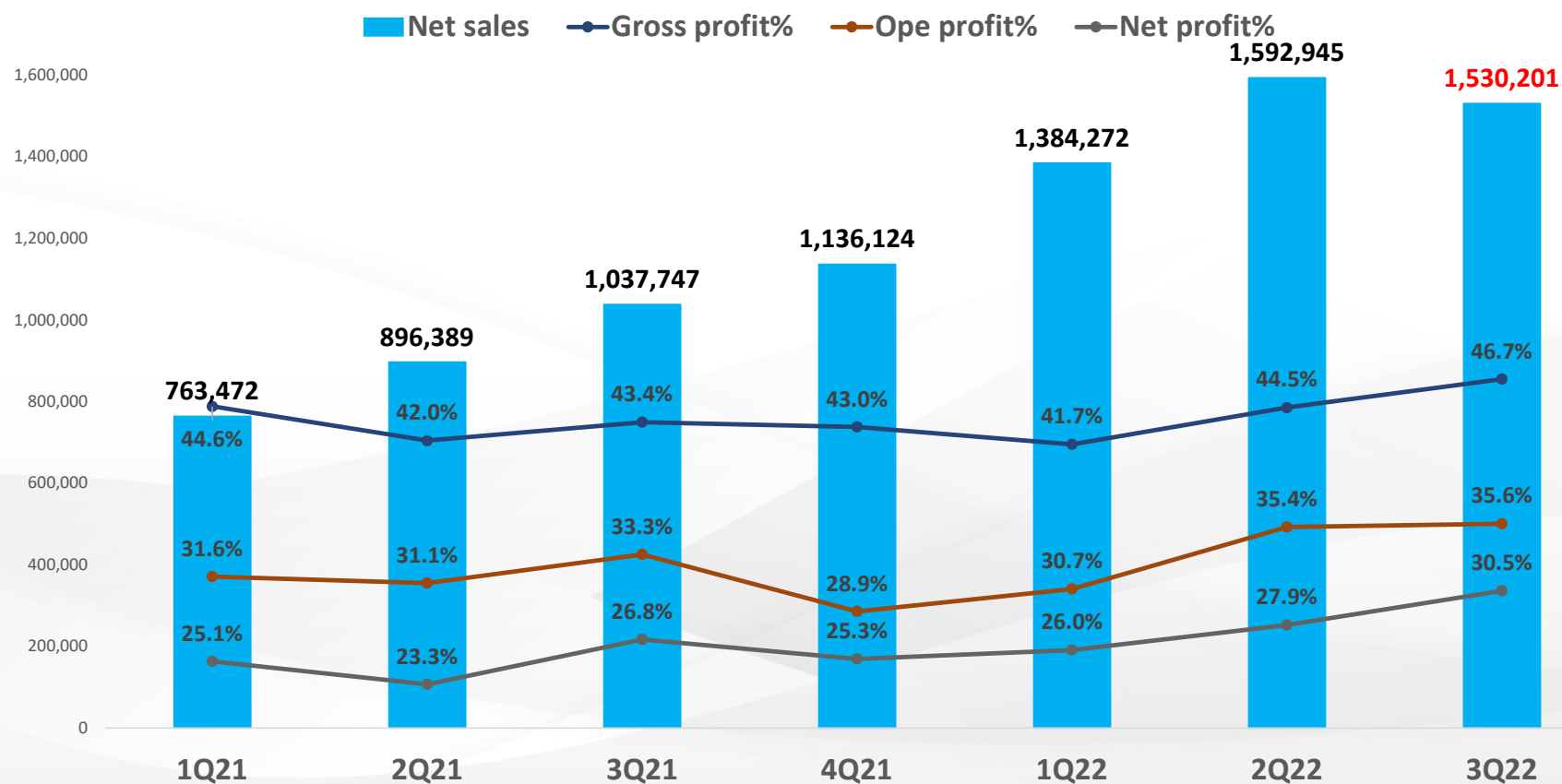

季度營業收入-產業別%

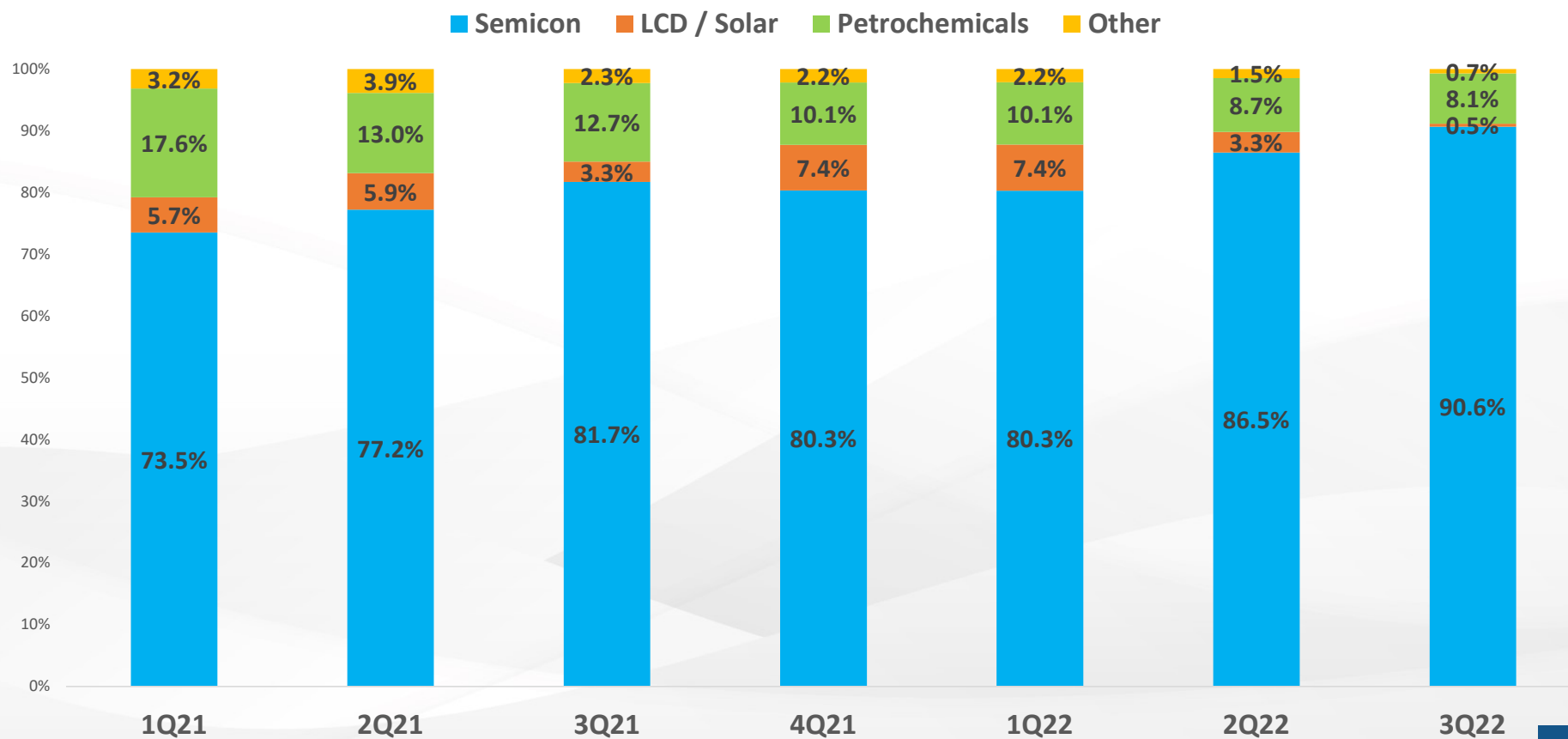

季度營業收入-產品別%

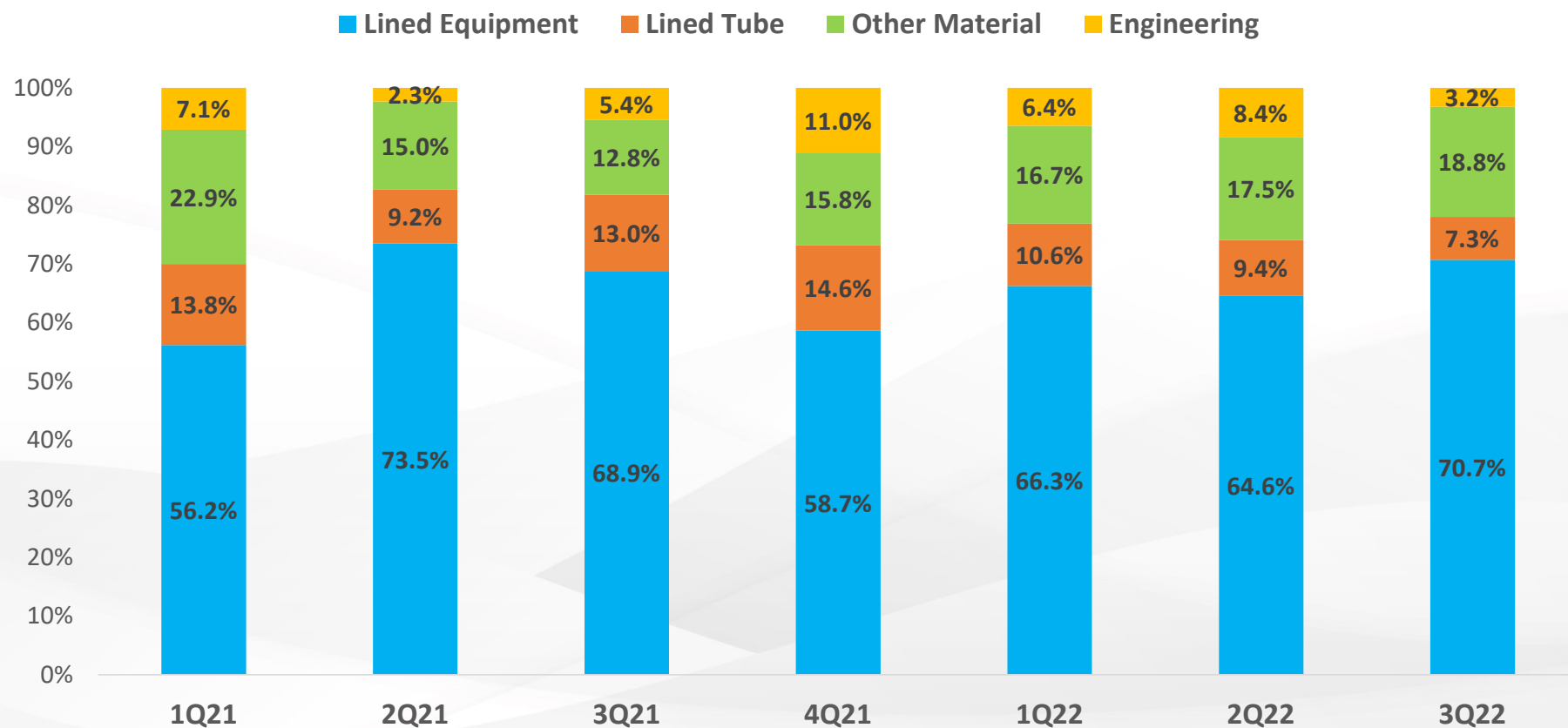

季度營業收入-地區別% (*係客戶下單來源地區)

FY2021 地區別營收 Revenue by Area

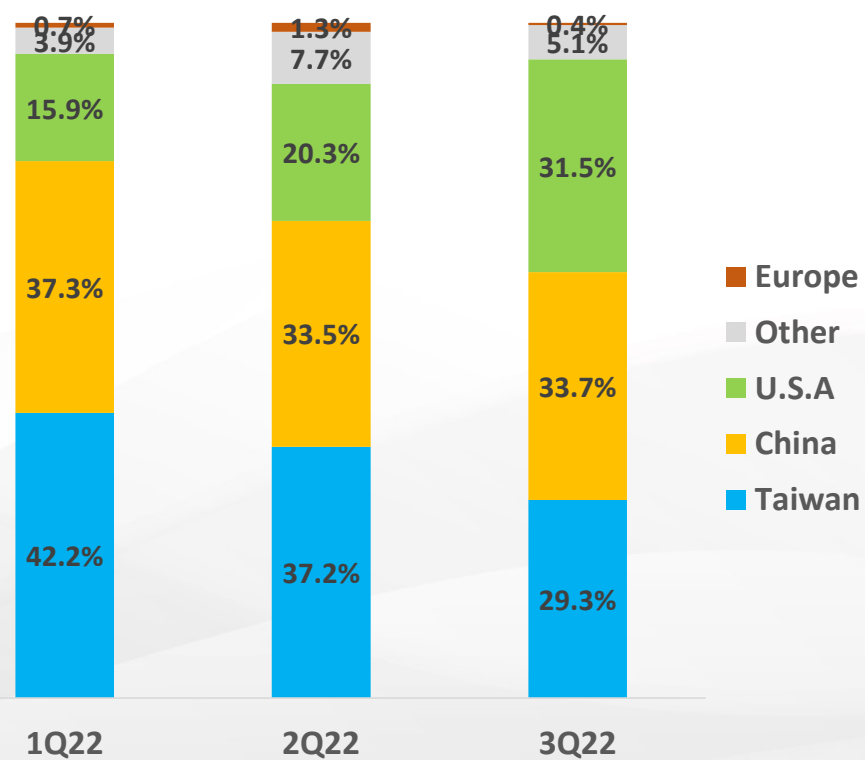
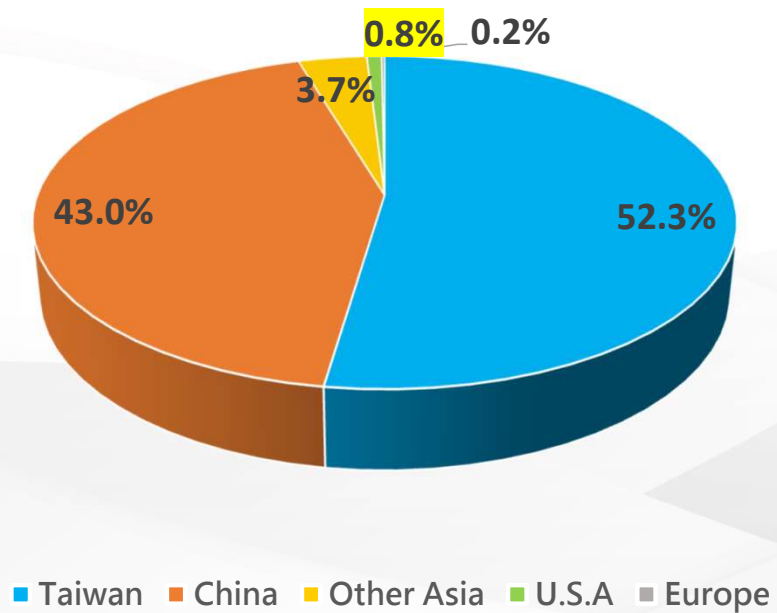

合併資產負債表 & 關鍵指標

新台幣仟元

資產負債表項目	3Q22		2Q22		3Q21	
	Amount	%	Amount	%	Amount	%
現金及銀行存款	3,369,704	37.8%	3,331,051	39.5%	1,479,677	25.5%
應收票據及帳款	1,424,409	16.0%	1,344,842	16.0%	1,097,276	18.9%
存貨	1,806,756	20.3%	1,580,337	18.8%	1,207,752	20.8%
其他金融資產-流動	279,803	3.1%	250,082	3.0%	343,761	5.9%
其他流動資產	216,588	2.4%	195,634	2.3%	160,494	2.8%
流動資產	7,097,260	79.7%	6,701,946	79.5%	4,288,960	73.9%
不動產、廠房及設備	1,669,932	18.8%	1,559,335	18.5%	1,342,892	23.1%
使用權資產	59,838	0.7%	61,186	0.7%	57,930	1.0%
其他非流動資產	78,111	0.9%	105,000	1.2%	111,439	1.9%
非流動資產	1,807,881	20.3%	1,725,521	20.5%	1,512,261	26.1%
資產總計	8,905,141	100.0%	8,427,467	100.0%	5,801,221	100.0%
流動負債	2,176,312	24.4%	2,173,269	25.8%	1,880,653	32.4%
非流動負債	472,140	5.3%	483,581	5.7%	677,193	11.7%
負債總計	2,648,452	29.7%	2,656,850	31.5%	2,557,846	44.1%
股東權益總計	6,256,689	70.3%	5,770,617	68.5%	3,243,375	55.9%
平均收現日數	75		73		102	
平均銷貨日數	174		160		185	
流動比率	326.1%		308.4%		228.1%	
負債比率	29.7%		31.5%		44.1%	
資產報酬率	19.9%		19.4%		17.2%	
權益報酬率	29.2%		28.4%		29.7%	



03

Q & A



Thank you

TEFPASS@alliedsupreme.com

<https://www.alliedsupreme.com/>